

OWNER'S MANUAL

Mobile Audio/Video System

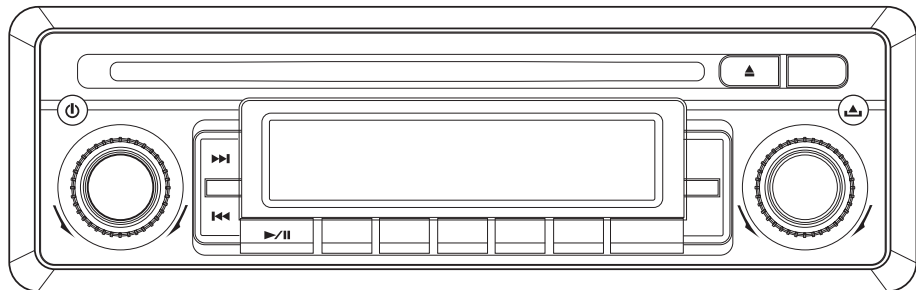
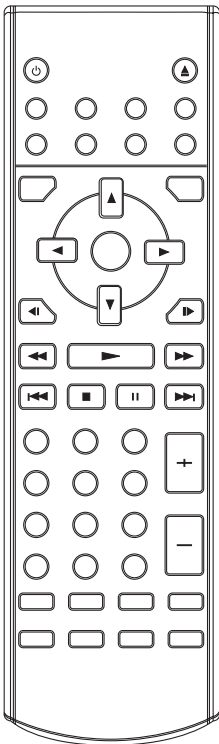

- **IN DASH SINGLE DVD/RADIO PLAYER**
- **AUDIO CD/CDR/CDRW/MP3 COMPATIBLE**
- **DETACHABLE FACE**
- **AM/FM RADIO TUNER**
- **REMOTE CONTROL HANDSET**
- **4 X 40 WATTS POWER OUTPUT**
- **2 PAIRS RCA LINEOUT**
- **AUX INPUT FUNCTION**
- **SUBWOOFER OUTPUT**

FEATURES

Compatible with PAL DVD (Video CD) and NTSC DVD (Video CD)

This player can play discs recorded in either PAL or NTSC format.

- A single LSI chip now integrates all major DVD playback circuit functions including MPEG2 decoder, video D/A converter, and audio decoders.
- L/R stereo analog audio outputs for connection to existing head unit aux inputs. Video output is composite video.
- Supplied remote handles multi-function software (multi-language audio-track/subtitle, multi-angle, multi-story, etc.), plus all basic functions.

Use Authorized Service Centres

Do not attempt to disassemble or adjust this precision product. Please refer to the Service Centre list included with this product for service assistance.

For Installation

The unit should be installed in a horizontal position with the front end up at a convenient angle, but not more than 30°.

USE THIS PRODUCT SAFELY

When Driving

Keep the volume level low enough to be aware of road and traffic conditions.

When Car Washing

Do not expose the product to water or excessive moisture. This could cause electrical shorts, fire or other damage.

When Parked

Parking in direct sunlight can produce very high temperatures inside your vehicle. Give the interior a chance to cool down before starting playback.

Use the Proper Power Supply

This product is designed to operate with a 12 volt DC, negative ground battery system (the regular system in a North American car).

Protect the Disc Mechanism

Avoid inserting any foreign objects into the slot of this player.

Failure to observe this may cause malfunction due to the precise mechanism of this unit.

CONTENTS

Safety Information	4
Disc Notes	5
Installation	6
Using the Detachable Front Panel	9
Wiring Connection	10
Location and Function of Keys	11
The Player	11
Remote Control	12
Remote Control	14
Preparing the Remote Control	14
General Operation	15
Basic Play Operation	16
Radio Operation	17
Advanced Operation	17
Repeat Play/ Paragraph Repeat Play	17
PBC Menu Playback of VCD/SVCD	17
On-screen Display Function	18
PAL/NTSC System Selection.....	19
Random Playing	19
Zoom Function	20
Special Function for DVD	20
Special Function for VCD	21
Data Disc and Audio CD Play Operation	21
Setup	23
Language Setup	23
Display Setup.....	24
Audio Setup	24
Lock Setup	25
Others Setup.....	25
Trouble Shooting	26
Specifications	27

SAFETY INFORMATION

CAUTION:

MOBILE DVD PLAYER IS A CLASS I LASER PRODUCT. HOWEVER THIS MOBILE DVD PLAYER USES A VISIBLE/INVISIBLE LASER BEAM WHICH COULD CAUSE HAZARDOUS RADIATION EXPOSURE IF DIRECTED. BE SURE TO OPERATE THE MOBILE DVD PLAYER CORRECTLY AS INSTRUCTED.

USE OF CONTROLS OR ADJUSTMENTS OR PERFORMANCE OF PROCEDURES OTHER THAN THOSE SPECIFIED HEREIN MAY RESULT IN HAZARDOUS RADIATION EXPOSURE. DO NOT OPEN COVERS AND - DO NOT REPAIR YOURSELF. REFER SERVICING TO QUALIFIED PERSONNEL.

WARNING:

- TO REDUCE THE RISK OF FIRE OR ELECTRIC SHOCK, DO NOT EXPOSE THIS EQUIPMENT TO RAIN OR MOISTURE.
- TO REDUCE THE RISK OF FIRE OR ELECTRIC SHOCK, AND ANNOYING INTERFERENCE, USE ONLY THE RECOMMENDED ACCESSORIES.
- THIS DEVICE IS INTENDED FOR CONTINUOUS OPERATION.

This product incorporates copyright protection technology that is protected by method claims of certain U.S. patents and other intellectual property rights owned by Macrovision Corporation and other rights owners. Use of this copyright protection technology must be authorized by Macrovision Corporation, and is intended for home and other limited viewing uses only unless otherwise authorized by Macrovision Corporation. Reverse engineering or disassembly is prohibited.

Region Management Information

Region Management Information:

This Mobile DVD Player is designed and manufactured to respond to the Region Management Information that is recorded on a DVD disc. If the Region number described on the DVD disc does not correspond to the Region number of this Mobile DVD Player, this Mobile DVD Player cannot play this disc.

DISC NOTES

Disc formats supported by this player



DVD
12 cm disc



Video CD
12 cm disc



CD
12 cm disc



MP3
12 cm disc

Discs which cannot be played with this player

- DVD-ROM
- DVD-R/DVD-RAM
- CDV
- CD-G

Handling and Cleaning

- Dirt, dust, scratches and warping disc will cause misoperation.
- Do not place stickers or make scratches on discs.
- Do not warp discs.
- A disc should always be kept in its case when not in use to prevent from damaging.
- Do not place discs in the following places:
 1. Direct sunlight
 2. Dirty, dusty and damp areas
 3. Near car heaters
 4. On the seats or dashboard

Disc Cleaning

Use a dry soft cloth to wipe the surface. If the disc is quite dirty, use a soft cloth slightly moistured with isopropyl (rubbing) alcohol. Never use solvents such as benzine, thinner or conventional record cleaners as they may mar the surface of the disc.

Note:

A disc may become somewhat scratched (although not enough to make it unusable) depending on your handle it and conditions in the usage environment.

Note these scratches are not an indication of any problem with the player.

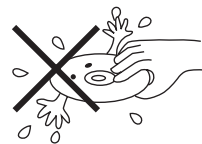
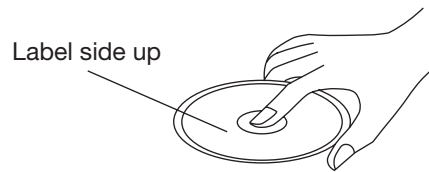

Do not touch the underside of the disc

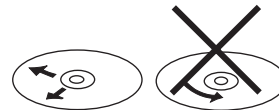

Wipe the disc from center toward the outside edge

Preparing New Discs with Rough Spots

A new disc may have rough edges on its inside and outside edges. If a disc with rough edges is used, the proper setting will not be performed and the player will not play the disc. Therefore, remove the rough edges in advance by using a ball point pen or pencil as shown on the right. To remove the rough edges, press the side of the pen or pencil against the inside and outside edges of the disc.

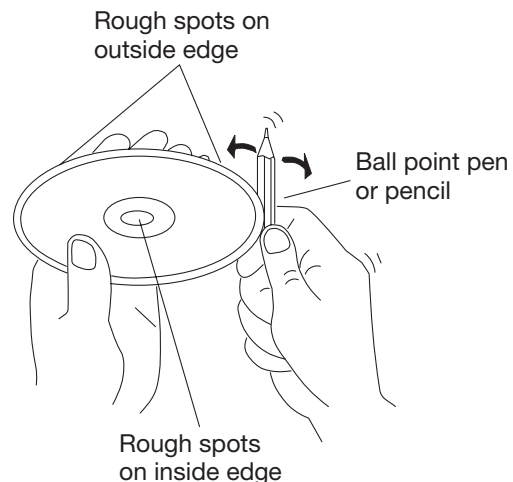

INSTALLATION

Notes:

- Choose the mounting location where the unit will not interfere with the normal driving function of the driver.
- Before finally installing the unit, connect the wiring temporarily and make sure it is all connected up properly and the unit and the system work properly.
- Use only the parts included with the unit to ensure proper installation. The use of unauthorized parts can cause malfunctions.
- Consult with your nearest dealer if installation requires the drilling of holes or other modifications of the vehicle.
- Install the unit where it does not get in the driver's way and cannot injure the passenger if there is a sudden stop, like an emergency stop.
- If installation angle exceeds 30° from horizontal, the unit might not give its optimum performance.

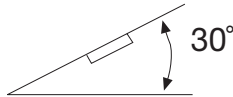

- Avoid installing the unit where it would be subject to high temperature, such as from direct sunlight, or from hot air, from the heater, or where it would be subject to dust, dirt or excessive vibration.

DIN FRONT/REAR-MOUNT

This unit can be properly installed either from “Front” (conventional DIN Front-mount) or “Rear” (DIN Rear-mount installation, utilizing threaded screw holes at the sides of the unit chassis). For details, refer to the following illustrated installation methods.

DIN FRONT-MOUNT (Method A) Installation Opening

This unit can be installed in any dashboard having an opening as shown below:

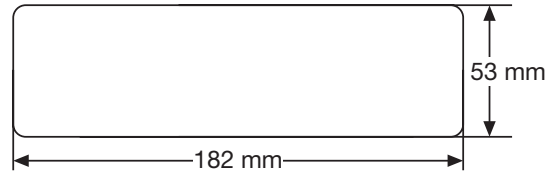

Installing the unit

Be sure you test all connections first, and then follow these steps to install the unit.

1. Make sure the ignition is turned off, and then disconnect the cable from the vehicle battery's negative (-) terminal.
2. Disconnect the wire harness and the antenna.
3. Press the release button on the front panel and remove the control panel (see the steps of “removing the front panel”).
4. Lift the top of the outer trim ring then pull it out to remove it.
5. The two supplied keys release tabs inside the unit's sleeve so you can remove it. Insert the keys as far as they will go (with the notches facing up) into the appropriate slots at the middle left and right sides of the unit. Then slide the sleeve off the back of the unit.

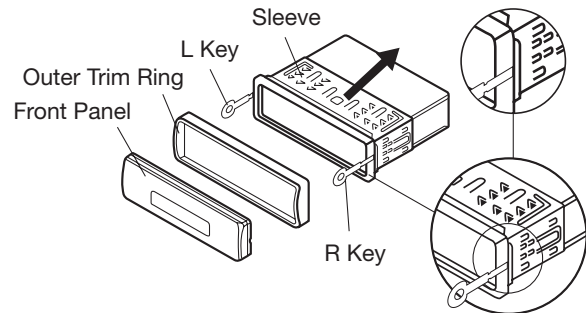

INSTALLATION

6. Mount the sleeve by inserting the sleeve into the opening of the dashboard and bend open the tabs located around the sleeve with a screwdriver. Not all tabs will be able to make contact, so examine which ones will be most effective. Bending open the appropriate tabs behind the dashboard to secure the sleeve in place.

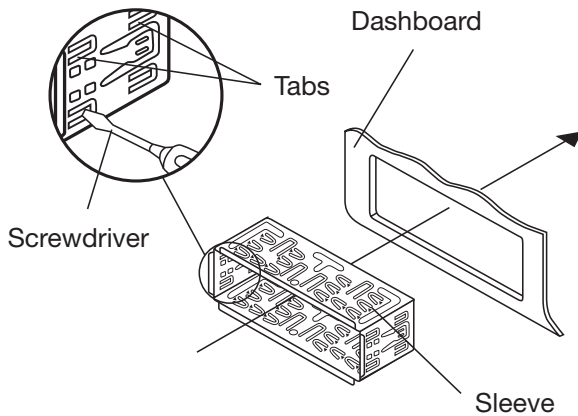

7. Reconnect the wire harness and the antenna and be careful not to pinch any wires or cables.
8. Slide the unit into the sleeve until it locks into place.
9. To further secure the unit, use the supplied metal strap to secure the back of the unit in place. Use the supplied hardware (Hex Nut (M5mm) and Spring Washer) to attach one end of the strap to the mounting bolt on the back of the unit. If necessary, bend the metal strap to fit your vehicle's mounting area. Then use the supplied hardware (Tapping Screw (5x25mm) and Plain Washer) to attach the other end of metal strap to a solid metal part of the vehicle under the dashboard. This strap also helps ensure proper electrical grounding of the unit.
Note to install the short threading terminal of the mounting bolt to the back of the unit and the other long threading terminal to the dashboard.

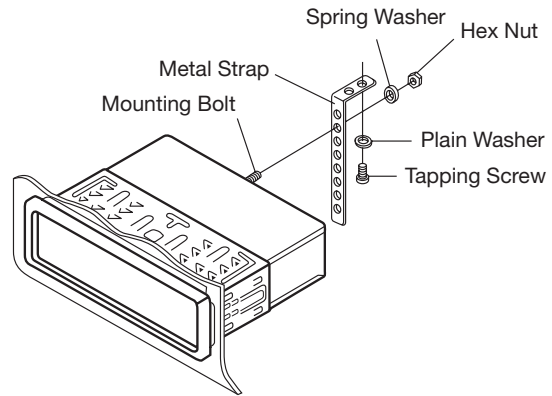

10. Reconnect the cable to the vehicle battery's negative (-) terminal. Then replace the outer trim ring and install the unit's front panel. (see the steps of "installing the front panel").

Removing the unit

1. Make sure the ignition is turned off, then disconnect the cable from the vehicle battery's negative (-) terminal.
2. Remove the metal strap attached the back of the unit (if attached).
3. Press the release button to remove the front panel.
4. Lift the top of the outer trim ring then pull it out to remove it.
5. Insert both of the supplied keys into the slots at the middle left and right sides of the unit, then pull the unit out of the dashboard.

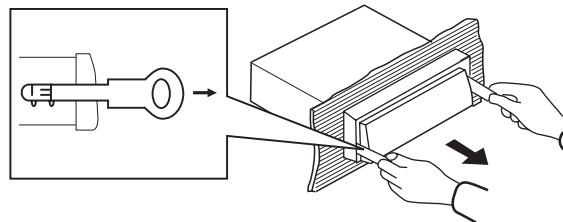

INSTALLATION

DIN REAR-MOUNT (Method B)

If your vehicle is a Nissan, Toyota, follow these mounting instructions.

Use the screw holes marked T (Toyota), N (Nissan) located on both sides of the unit to fasten the unit to the factory radio mounting brackets supplied with your vehicle.

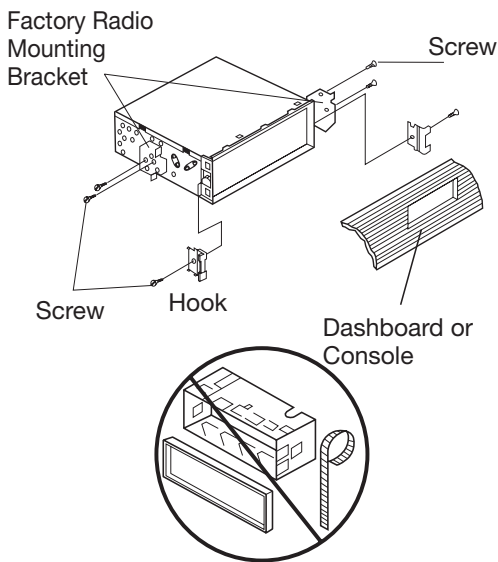
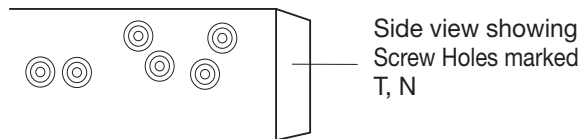

To fasten the unit to the factory radio mounting brackets.

1. Use a screwdriver to loose the hook's screws of the front left and right sides of the unit and remove the hooks.
2. Align the screw holes on the bracket with the screw holes on the unit, and then tighten the screws (5x5mm) on each side.

Note: the outer trim ring, sleeve and the metal strap are not used for method B installation.

USING THE DETACHABLE FRONT PANEL

REMOVING THE FRONT PANEL

1. Press the release button (REL) on the front panel and pull off the front panel.

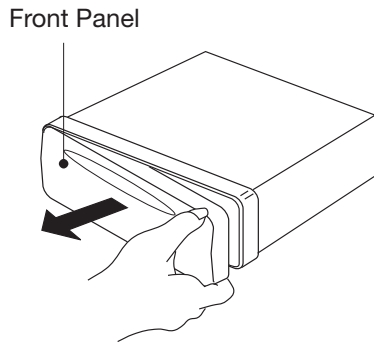
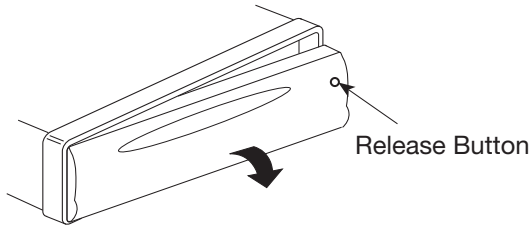

2. Keep front panel into the case.

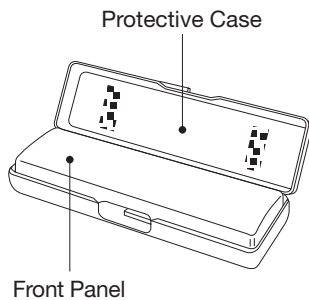

INSTALLING THE FRONT PANEL

To install the front panel, insert the panel into the housing and make sure the panel is properly installed. Otherwise, abnormality occurs on the display or some keys will not function properly.

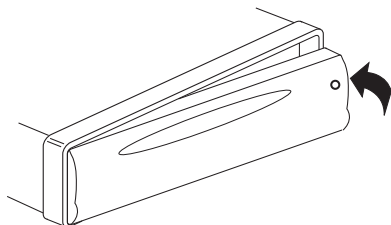

Precautions when handing

1. Do not drop the front panel.
2. Do not put pressure on the display or control buttons when removing or installing the front panel.
3. Do not touch the contacts on the front panel or on the main unit body. It may result in poor electrical contact.
4. If any dirt or foreign substances adhered on the contacts, they can be removed with a clean and dry cloth.
5. Do not expose the front panel to high temperatures or direct sunlight in anywhere.
6. Keep away any volatile agents (e.g. benzene, thinner, or insecticides) from touching the surface of the front panel.
7. Do not attempt to disassemble the front panel.

WIRING CONNECTION

20 PIN SOCKET CONNECTIN

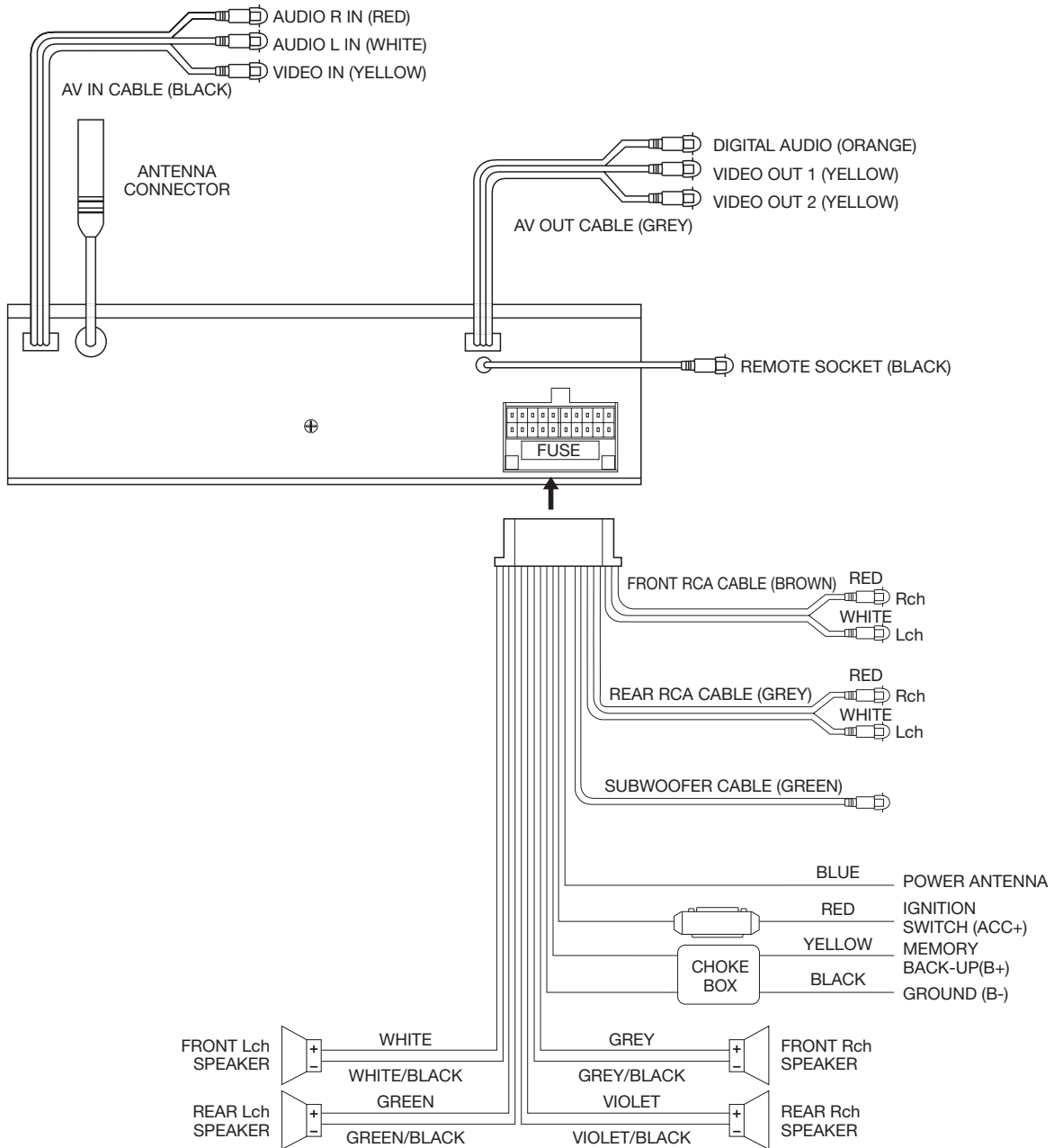

LOCATION AND FUNCTION OF KEYS

THE PLAYER

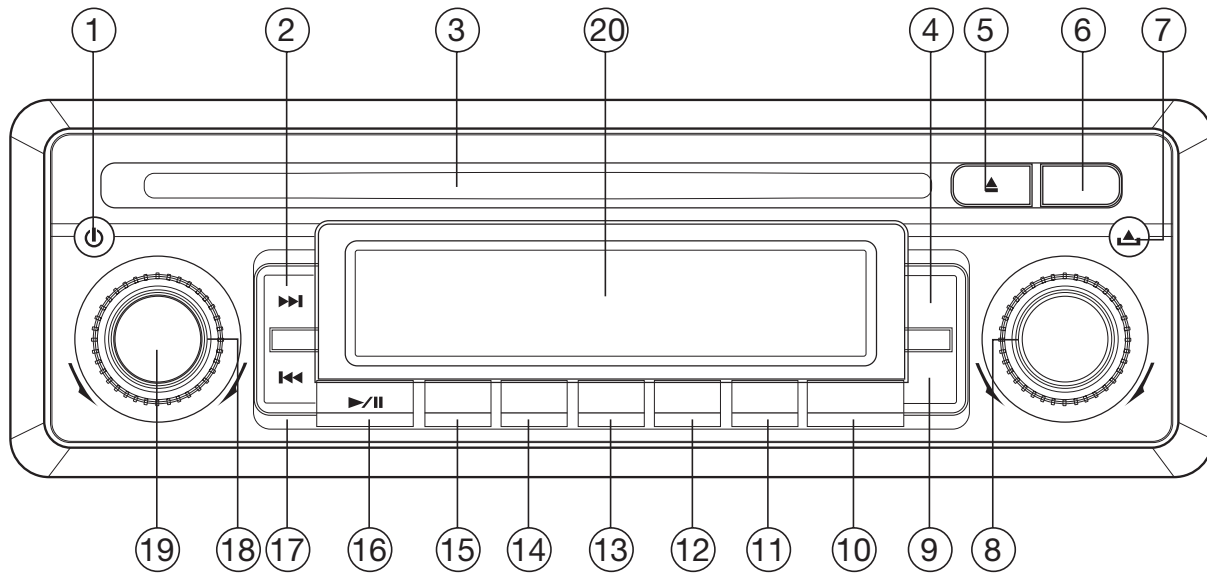

- | | |
|-----------------|----------------------------|
| 1. POWER | 12. BND/LOUD |
| 2. ►► | 13. MON |
| 3. Disc Slot | 14. RDM |
| 4. SEL EQ (SW) | 15. RPT |
| 5. ▲ | 16. ►/ |
| 6. Disc Slot IR | 17. ◀◀ |
| 7. REL (▲) | 18. VOLUME knob |
| 8. TUNING knob | 19. SEL |
| 9. MODE | 20. Liquid Crystal Display |
| 10. DSP | |
| 11. MUTE | |

When remove the front panel:

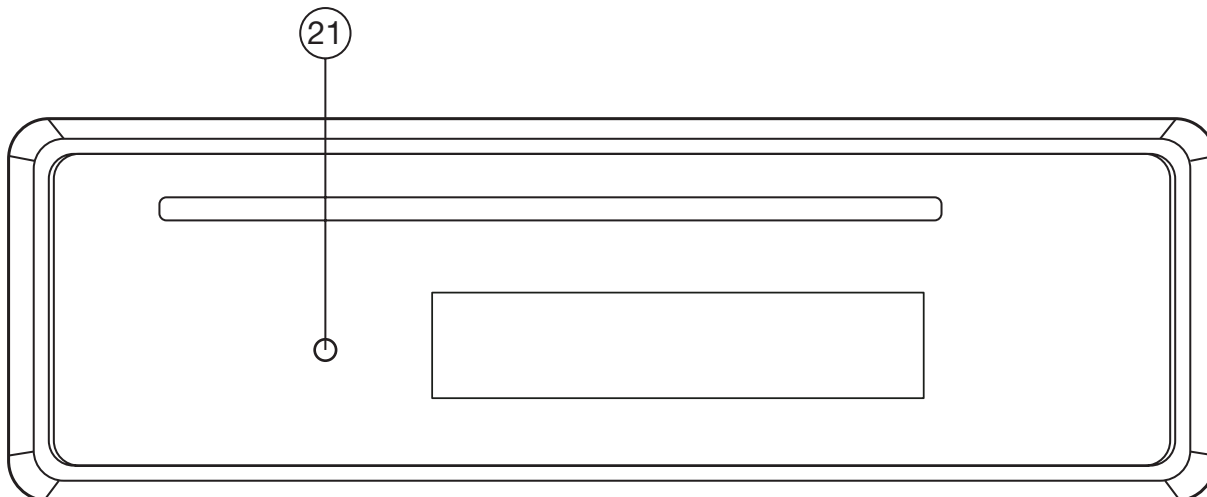







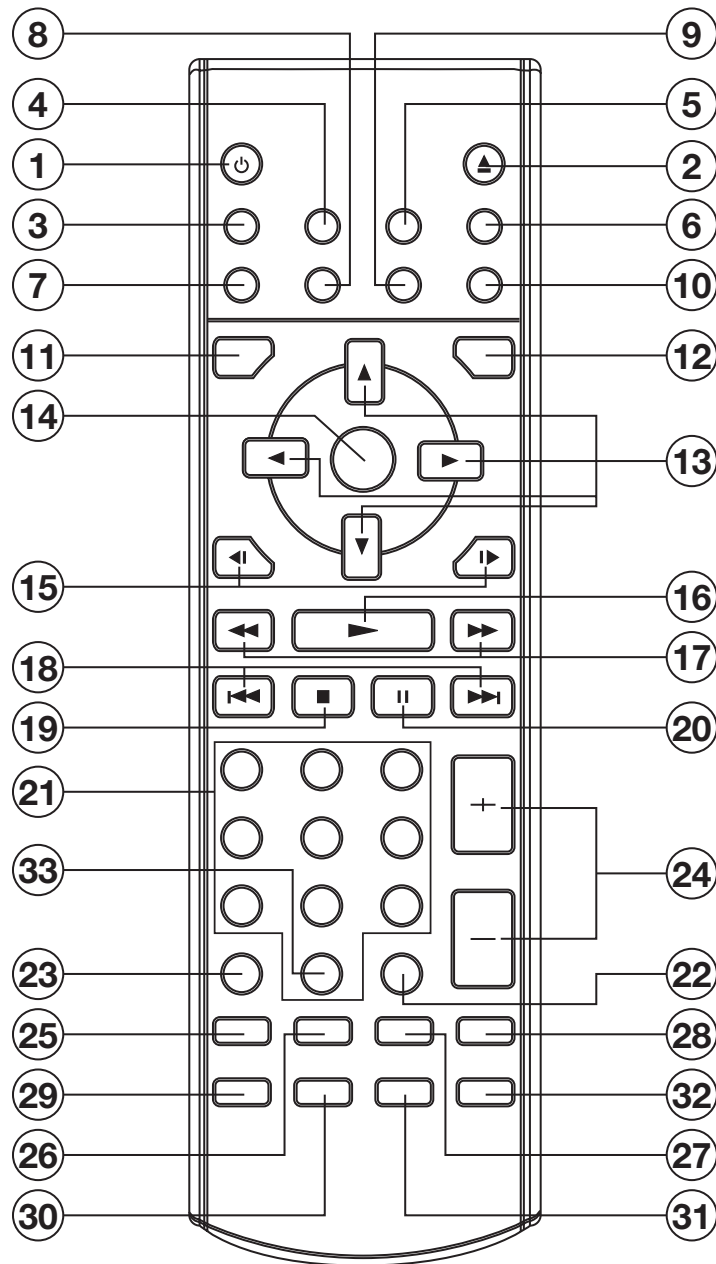















21. RESET button

LOCATION AND FUNCTION OF KEYS

REMOTE CONTROL



LOCATION AND FUNCTION OF KEYS

1.  POWER Press POWER to turn the unit ON or OFF.
2. EJECT Press to eject the disc.
3. MUTE Press to mute the sound.
4. SUBTITLE Changing of the SUBTITLE language on multi-subtitle language DVD disc.
5. ANGLE Changing of the view angle on multi-angle DVD disc.
6. CONSOLE Display statistical disc information during playback.
7. MODE Changing between radio, disc (DVD/VCD/CD/MP3) play mode and AV mode.
8. SETUP Display the SETUP menu.
9. PAL/NTSC Change between PAL , NTSC and AUTO mode.
10. AUDIO Changing of the AUDIO soundtrack on multi-audio soundtrack DVD disc.
Changing of the sound mode of the VCD/CD discs.
11. TITLE Display the TITLE menu that is stored in DVD disc.
12. MENU Display the root menu that is stored on the DVD disc.
13.  /  ,  /  In case of MENU mode,  /  ,  /  buttons served as cursor buttons to select item left/right, ahead/back.
14. ENTER Confirm the Track/Chapter selected with the numeric buttons or selected with the cursor buttons on TV screen.
15.  /  Changing for slow forward/ reverse playback motion.
16.  Press to play the disc.
17.  /  Press  to search forward rapidly &  to search reverse rapidly.
18.  /  Press  to skip to the next track & press  to skip back one track.
19.  Press it to stop playback.
20.  Press it to pause playback.
21. 0-9 Numeric buttons
22. 3D (LOC) Numeric button, cooperatively used with 0-9 numeric buttons.
In radio mode, press and hold it for a long time to select between local and distant stations.
23. CLEAR(MO/ST) When you input a number in error, press the button to clear it.
In radio mode, press it to select mono or stereo mode.
24. VOLUME+/- Press VOLUME+/- button to increase or decrease the volume level.
25. PBC Changing between PBC ON and PBC OFF on the VCD disc.
26. EQ Press it to select the equalization mode, such as FLAT, CLAS, POP, ROCK.
27. LOUD Press to reinforce the bass output. Press it again to release this function.
28. SEL Press to select the desired adjustment mode. Then press VOLUME+/- to change settings.
29. ZOOM Allows the picture to be increased in size.
30. PROGRAM Allows the track played in the order you programmed.
31. REPEAT Switch the Repeat mode of discs.
32. A-B A-B repeat allows a passage to be repeated continuously.
33. BAND In radio mode, press it to select desired band.

REMOTE CONTROL

Preparing the Remote Control

Inserting the Batteries

1. Open the battery compartment cover.
2. Insert the new battery. Make sure that the positive and negative terminals of the battery are oriented as indicated.
3. Close the cover.

Battery: Two AAA battery

Using the Remote Control

Point the remote control towards the player front face remote sensor **IR** (remote control signal receiver).

Operation angle: About ± 30 degree in each the direction of the front of the remote sensor.

GENERAL OPERATION

TURNING ON THE PLAYER

Press the **POWER** button on the front panel to turn on the power. When the unit is on, it will search the disc automatically. If there is a disc in the disc slot, the unit will start playback automatically. Beside this, you should turn on the monitor that is connected to the player.

Note: The unit has screen saver function (select "ON" in Screen Saver setup). If the playback is stopped and there is not any button operation in 5 minutes, it will activate the screen saver function automatically; when any button for DVD function is pressed, the screen saver function will release automatically.

Remote Sensor (IR)

Point the remote handset to the remote sensor **IR** on the front panel. Receive the signal from remote handset.

Loading a Disc

1. Insert the disc with printed side facing up into the disc slot.
2. The player will start playback automatically.

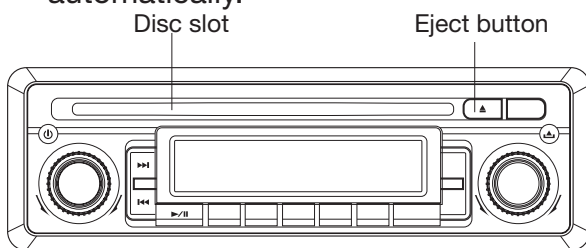

Ejecting a Disc

Press **▲** (EJECT) button on the front panel or on the remote control to eject the disc.

FACEPLATE RELEASE

Press **REL (▲)** button on the front panel to detach the removable faceplate.

SOUND ADJUSTMENT

Press **SEL** button on the front panel of the unit or on the remote control to select the desired adjustment mode. The adjustment mode will change in the following order:



By rotating the **VOLUME** knob on the front panel or **VOLUME +/-** buttons on the remote control clockwise or counter-clockwise, it is possible to adjust the desired sound quality.

LOUDNESS

Press and hold **BND/LOUD** button on the front panel for several seconds or press **LOUD** button on the remote control to reinforce the bass output. Press **BND/LOUD** button on the front panel for several seconds again or press **LOUD** button on the remote control again to release this function.

SET THE CLOCK

Press the **DSP** button on the front panel, the clock is shown on the LCD display. Then press **SEL** button on the front panel or on the remote control shortly, the hour will be flashing. Then rotate the **VOLUME** knob on the front panel or **VOLUME +/-** button on the remote control to change hours. And then press **SEL** button to confirm it. Press **SEL** button again, the minute will be flashing. Then you can change the minutes according to the operation described above.

Mute

Press **MUTE** button on the front panel or **MUTE** button on the remote control to mute down the sound instantly. Press it again to resume sound output.

Volume Level Adjustment

Rotate **VOLUME** knob on the front panel or press **VOLUME +/-** on the remote control to increase or decrease the volume level.

EQUALIZATION

Press **EQ** button shortly to turn on equalization function and to select desired audio mode. There are four kinds of mode as follows:

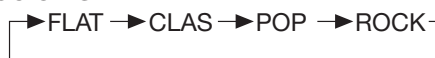

SUBWOOFER

Press **EQ (SW)** button on the front panel for several seconds to toggle sub-woofer output. Press it for several seconds again to release this mode.

MODE SELECTION

Press **MODE** button on the front panel of the unit or **MODE** button on the remote control to select among radio, disc (DVD/VCD/CD/MP3) play mode and AV IN mode.

GENERAL OPERATION

LIQUID CRYSTAL DISPLAY

Exhibit current frequency and activated functions on the display of the front panel.

RESET FUNCTION

RESET button is placed on the front panel and must be activated with either a ballpoint pen or thin metal object. The reset button is to be activated for the following reasons:

- Initial installation of the unit when all wiring is completed.
- All the function buttons do not operate.
- Error symbol on the display.

Note: if press **RESET** button, the unit can't work yet, please use a cotton swab soaked in isopropyl alcohol to clean the socket on the front panel.

LAST PLAY MEMORY

- During disc playback, if you press **POWER** button to turn off the unit and then press the button again to turn on the unit, the DVD unit will resume playing from the point that just interrupted.
- During disc playback, if you press **MODE** button to switch to radio mode or AV mode, then return to DVD mode again, the unit will resume playing from the point that just interrupted.
- During disc playback, press **REL** button to release the front panel, the unit will enter into standby state. Then install the front panel again, the unit will resume playing from the point that just interrupted. If in AV mode or radio mode, release the panel then install again, the unit will remain in the previous mode.
- Switch the ignition key to "ACC OFF" then switch to "ACC ON", the unit will remain in the previous mode. If in disc play mode, it will resume playing from the point that just interrupted.

AV IN OPERATION

When you connect another audio/video system to the unit through the AV IN terminals on the back of the unit, press **MODE** button on the front panel or **MODE** on the remote control to select AV IN mode.

Stopping Playback

- Briefly press **Stop** button to pre-stop the unit playback, when **Play/Pause** button on the front panel or **Play** button on the

BASIC PLAY OPERATION

remote control is pressed, normal playback will continue.

- Press **Stop** button twice to stop the playback and go back to DVD LOGO.

Pausing Play/Step Play

Pressing **Pause** on the remote control for the first time or pressing **Play/Pause** on the front panel during playback will stop playback temporarily. To return to normal playback, press **Play** on the remote control or **Play/Pause** on the front panel. If you play a DVD/VCD/SVCD, press **Pause** on the remote control again to stop at the next picture (step function). If you play a CD/MP3/Picture CD, pressing **Pause** on the remote control again is ineffective.

Rapid Forward/Rapid Reverse

Press **Fast Forward** & **Fast Reverse** on the remote control or hold **Fast Forward** / **Fast Reverse** buttons on the front panel for several seconds during playback. Each time the button is pressed, the speed of rapid forward/reverse changes according to the disc as follows.

DVD:

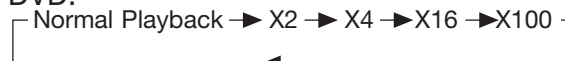

VCD/CD/MP3:



Slow Motion Playback (For DVD Only)

Press **Slow Forward** / **Slow Reverse** during play.

Each time the button is pressed, the speed of slow forward/reverse changes according to the disc as follows.

DVD:

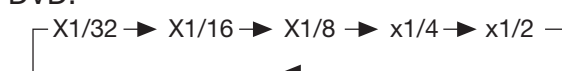

In slow motion state, press **Play** on the remote control to recover normal playback.

Skipping Track

Press **Next Track** / **Previous Track** buttons on the remote control or on the front panel during playback. Press **Next Track** to skip to the next track, and press **Previous Track** to skip to the previous track.

Note: For some VCD2.0 discs (PBC-playback control), **Next Track** / **Previous Track** buttons may be unavailable.

DVD VIDEO MENU PLAY

When playing a DVD disc in the DVD player:

- 1) The disc will be played automatically and stop at menu picture.
- 2) Use **Left/Right**, **Up/Down** cursor buttons to move between the highlight bars in the menu.
- 3) Press **ENTER** button to confirm the selected item.

SWITCHING TO RADIO MODE

Press **MODE** button to select radio mode, the radio mode appears in the display together with the memory band and frequency.

BAND

For the unit with two bands only, press **BND/LOUD** button on the front panel or press **BAND** button on the remote control shortly to change bands as below:

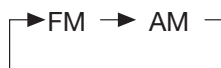

SELECT STATION

Rotate **TUNING** knob on the front panel clockwise or counter-clockwise to adjust the frequency upward or downward.

LOCAL/DISTANT

Press **3D (LOC)** button on the remote control to select between local setting for reception of strong station and distant setting for reception of weak stations when tuning.

MONO/STEREO

In FM band, press **MON** button on the front panel or press **MO/ST** button on the remote control to select mono or stereo reception for radio stations. You can sometimes improve reception of distant stations by selecting mono operation.

REPEAT PLAY/ PARAGRAPH REPEAT PLAY

Repeat play: when you want to repeat playing the whole disc or a track or a chapter in the disc.

- 1) Press **REPEAT** button repeatedly to select different repeat modes.
- 2) For different kinds of disc, pressing **REPEAT** button has different effects.

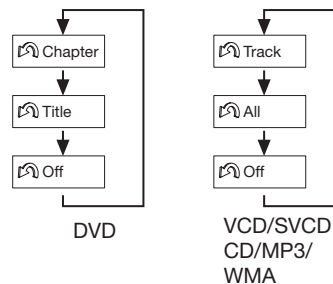

Note: REPEAT feature does not support VCD2.0 (with PBC ON).

Paragraph Repeat Play: when you want to repeat playing a desired paragraph.

A-B repeat allows a passage to be repeated continuously.

- 1) Press **A-B** button first at the start of the required passage.



- 2) Press **A-B** button secondly at the end of the passage.



- 3) Then the unit will repeat playing the passage you just set from A to B.
- 4) To revert to normal playing, press **A-B** button again.



PBC MENU PLAYBACK OF VCD/SVCD

For some VCD or SVCD discs, there is a menu in order to select the desired contents. This menu is called PBC (Playback Control) menu.

Press **PBC** button on the remote control to change between PBC ON and PBC OFF on the disc.

In PBC ON mode, REPEAT, RANDOM, A-B, PROGRAM functions are unavailable.

ADVANCED OPERATION

ON-SCREEN DISPLAY FUNCTION

Press the **CONSOLE** button during playback to display the console information of the current disc on the screen.

For DVD:

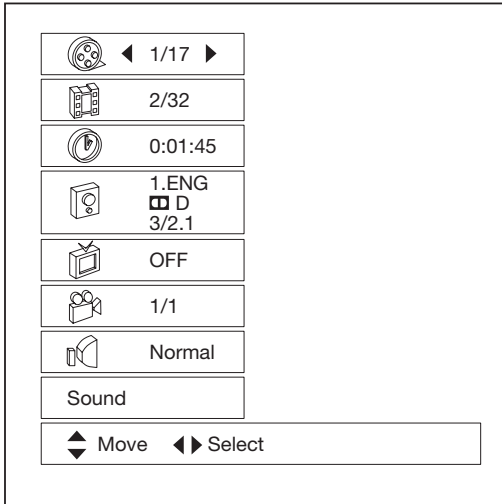

Item: Title

Function: Display the current title number and the total title number; it can skip to the desired title number.

Method: ◀/▶ buttons or use numeric buttons to input and confirm with **ENTER** button.



Item: Chapter

Function: Display the current chapter number and the total chapter number; it can skip to the desired chapter number.

Method: ◀/▶ buttons or use numeric buttons to input and confirm with **ENTER** button.



Item: Time

Function: Display the elapsed time; you can input the time directly to skip to the corresponding playback point.

Method: Use numeric buttons to input

time and confirm with **ENTER** button.



Item: Audio

Function: Display the current audio soundtrack language and digital audio output; it can switch to other audio soundtrack language and digital audio output.

Method: ◀/▶ buttons or press **AUDIO** button.

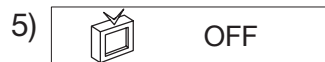

Item: Subtitle

Function: Display the current subtitle language; it can switch to other subtitle language.

Method: ◀/▶ buttons or press **SUBTITLE** button.



Item: Angle

Function: Display the current angle; it can switch to other angle.

Method: ◀/▶ buttons or press **ANGLE** button.



Item: Sound

Function: Display the current sound mode; it can switch between normal and 3D surround effect mode.

Method: ◀/▶ buttons or **3D** button.

For VCD:

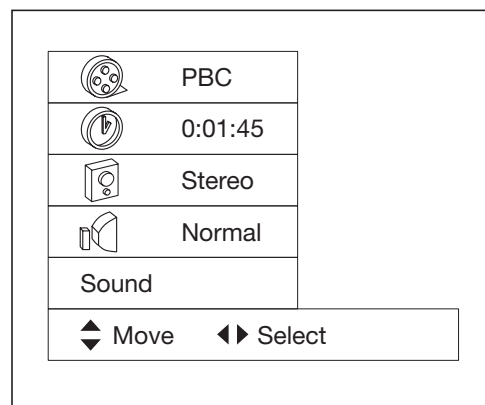

ADVANCED OPERATION



Item: Track

Function: When it is in PBC ON mode, it display “PBC” (only display, can’t be changed); when it is in PBC OFF mode, it will display the current track number and total track number (such as “1/16”) and it can skip to the desired track number.

Method: When in PBC OFF, press ◀ / ▶ buttons or use numeric buttons to input and confirm with **ENTER** button.



Item: Time

Function: Display the elapsed time; you can input the time directly to the skip to the corresponding playback point.

Method: In PBC mode, it can’t be changed. In PBC OFF mode, use numeric buttons to input time and confirm with **ENTER** button.



Item: Audio

Function: Display the current audio mode; it can switch to other audio mode.

Method: ◀ / ▶ buttons or press **AUDIO** button.



Item: Sound

Function: Display the current sound mode; it can switch between normal and 3D surround effect mode.

Method: ◀ / ▶ buttons or 3D button.

Note: The function is only effective when the LOGO is shown. That is to say, when no disc in, ejecting a disc and in stop mode or pre-stop mode when playing DVD/VCD, pressing PAL/NTSC is effective.

RANDOM PLAYING

Pressing **RANDOM** button during playback will start to play tracks in random order. Press the button again to revert to normal playback.

Note:

- This function is effective on VCD, SVCD and CD.
- When playing a VCD/SVCD, the random playback is effective with PBC OFF.

PAL/NTSC SYSTEM SELECTION

Press the **P/N** button to switch between PAL, NTSC and AUTO three modes.

ADVANCED OPERATION

ZOOM FUNCTION

When playing DVD, VCD or some data discs which including picture files, if you want to view the some part of the picture clearer:



1) Press **ZOOM** button to zoom in the picture 4 times.

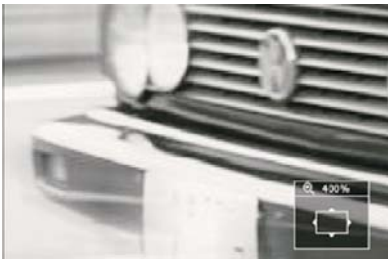

2) Press **ZOOM** button again to zoom in the picture 16 times.



- 3) During zoom mode, pressing **▲ / ▼, ◀ / ▶** buttons will move pictures up, down, left or right direction in order to find the picture that you want to zoom in.
- 4) When the sale is 16 times, press **ZOOM** button again to cancel the **ZOOM** function.

SPECIAL FUNCTIONS FOR DVD

Multi-subtitle Language Function

Press **SUB-T** during playback. The following information will be shown on the screen.



Each time the button is pressed, the subtitle language changes in sequential order.

Notes:

- The language number is different

according to the disc.

- Some discs only contain one subtitle language.

Multi-audio Language Function

Press **AUDIO** during playback. The following information will be shown on the screen.



Each time the button is pressed, the audio soundtrack language changes on sequential order.

Notes:

- The language number is different according to the disc.
- Some discs only contain one soundtrack language.

Multi-angle Function

Press **ANGLE** during playback. The following information will be shown on the screen.

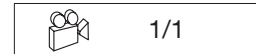

Each time the button is pressed, the angle changes in sequential order.

Notes:

- The angle number is different according to the disc.
- The function only works for discs having scenes recorded at different angles.

FREQUENTLY ASKED QUESTIONS

- When inserting a DVD disc, why it can't be played, just showing "region error"? It is because that the DVD player and the discs all have the "REGION CODE". If the region number described on the DVD disc does not correspond to the region number of this DVD player, the unit cannot play the disc.
- When inserting a DVD disc, there is a window shown on the screen that requires entering 4 characters password, why? It is because that the current disc has "Parental Control" level, and the player's parental level is set below the level of the disc, you should enter the correct password to play the disc normally.

ADVANCED OPERATION

NOTE:

- For how to set the “Parental Control” level, please refer to “SETUP\LOCK” in the following page.

ATTACHMENT: PARENTAL CONTROL

DVD discs have a parental level assigned to the disc. The range of parental controls is from 1 to 8. The player can be set in a similar way. If the player’s parental level is set to 8 it will play all discs. If the player’s parental level is set below 8, only discs with a lower or equal parental level will play.

For example if the player is set to 5, only discs with parental control ratings of 5, 4, 3, 2, & 1 will play. To play a higher rated disc you must change the player’s rating to a higher number.

For example, consider a disc that generally is suitable for most audiences, and is rated as level 2 for the most part. However in the middle there are also scenes rated at 5 & 7 (not suitable for children). Alternative scenes with lower rating are included.

The player plays the highest rated scene that the parental setting allows.

A section of the disc can have several different sequences that vary in parental control level. In the above example of a disc with parental control, the player will show a different section depending on the parental control level set in the player’s menu. In this way parents can control the content of films and there is no indication that any censorship has occurred.

The meaning of the levels 1 to 8 varies depending upon the country and the type of content on the disc.

The parental control levels are:

- Unlock
- 1 Kid safe
- 2 G
- 3 PG
- 4 PG 13
- 5 PG R
- 6 R
- 7 NC 17
- 8 Adult

The factory password of the parent control is “3351”.

SPECIAL FUNCTIONS FOR VCD

For VCD discs, there is one special function “Program Play” which makes it different from DVD discs.

- The function is effective in PBC OFF mode. In stop or pre-stop mode, press **PROGRAM** button can activate program edit interface.

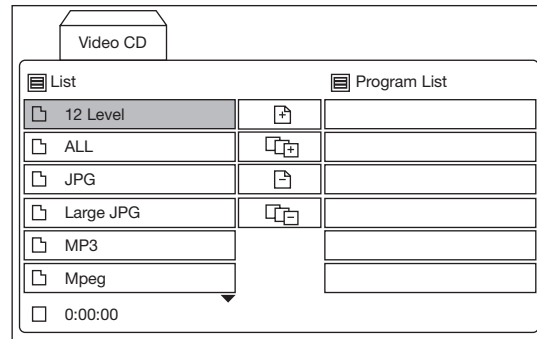

- For how to set the program menu, please refer to the operation of the audio files in the media player below.

Note:

- After you have programmed the tracks, press **PROGRAM** button can switch between program play and normal play.
- Press **▶** or **ENTER** button to exit the edit interface.

DATA DISC AND AUDIO CD PLAY OPERATION

When you insert a data disc including audio (MP3, WMA), movie (MPEG), picture (JPG) files or audio CD into the disc slot, the following media play window will be shown on the screen:

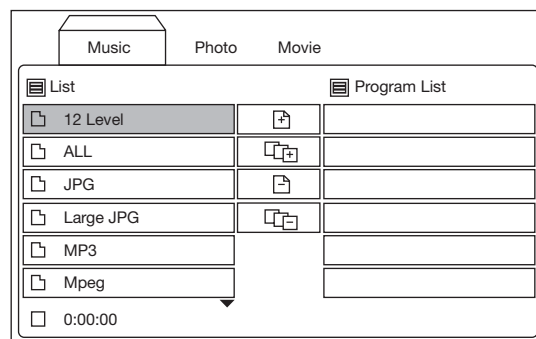

- 1) Press **TITLE** button to switch between Music, Photo and Movie these three pages.
- 2) In Music page, there are three areas: Play list, Program list and the Edit area in the middle.

ADVANCED OPERATION

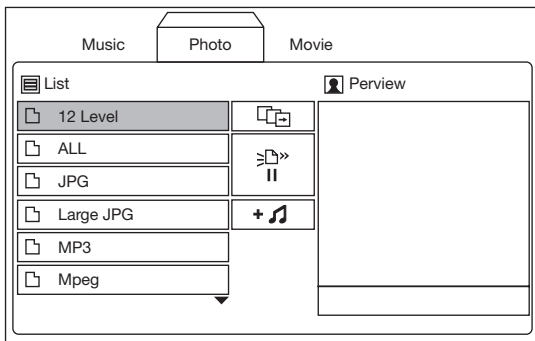

- Press **▶** or **ENTER** button to open the highlight folder in the play list or play the audio file in the play list or program list.
 - Use “ADD”, “ADD ALL”, “DELETE”, and “DELETE ALL” these four operation buttons on the middle edit area to edit the program list.
 - When highlight is on the audio file of the play list, you can press **PROGRAM** button to add the highlight file directly to the program list.
 - When highlight is on the program list, you can press **CLR** button to delete the highlight file directly.
- 3) In Photo page, there are three areas: Play list, Preview window and the Edit area in the middle.



- Press **▶** or **ENTER** button to open the highlight folder in the play list.
- When the highlight stops on the picture file, the preview of the picture will be shown in the preview window on the right.
- When selecting the  (slide show) button in the middle area and pressing **ENTER** to confirm, it will start to display all the pictures in full screen in turn. When show the picture in full screen, the control bar will be shown on the screen.



Press **◀** or **▶** button to rotate the picture 90° counter-clockwise or clockwise.
 Press **▲** / **▼** button to skip to the previous or next picture.
 Press **■** button to stop slide show.

- Press **CLR** button to hide or display the control bar.
- When selecting the  (Mixed Play) button in the middle area and pressing **ENTER** to confirm, it will start to display all the pictures in full screen in turn and add the MP3 file as background music.
 - The  (Speed) button in the middle area is used to adjust the display interval speed between the pictures. Press **◀** / **▶** buttons to switch between “>”, “>>”, “>>>” and “||”.
- 4) In Movie page, press **▶** or **ENTER** button to open the highlight folder in the play list or play the corresponding file.

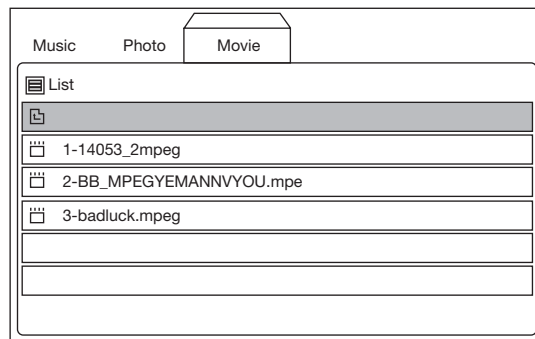

NOTE:
 For audio CD, the play interface and operation is similar with the Music page operation. For details, please refer to the description of Music page above.

SETUP

In the stop mode or when the disc is playing, press **SETUP** on the remote control to enter setup menu.

- When the cursor is on the topside, use ◀/▶ buttons to move between the different pages.
- Press ▼ button to move the cursor to the setup page below and then you can use ▲/▼ buttons to move between the different setup options.
- Press ▶ button to display the choice list for each setup option and then use ▲/▼ buttons and **ENTER** button to change your selection.

LANGUAGE SETUP

- When you open the setup menu, you will see the language setup page at first, see below:

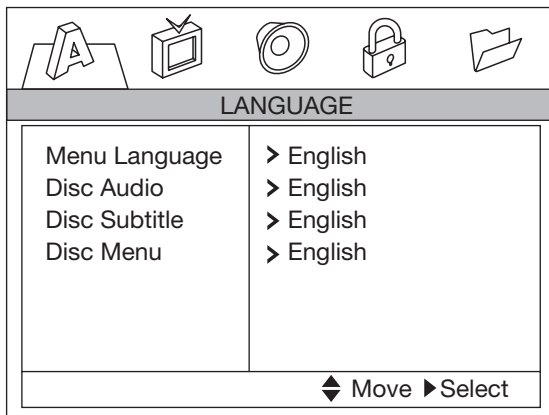

- “Menu Language” is used to change the language used in the whole menu and the all kinds of prompt information during playback. The unit has the following languages to be selected: English, Spanish, German, Italian, Portuguese, French and Russian.
- “Disc Audio” is used to set a preset value for the playback language of the DVD. When play a DVD disc, if the disc has a language that matches with the preset value, then it will play the language directly; if the disc isn’t including the language that matches with the preset, or the disc has the compelling playback language itself, then it will play the default language of the disc.
The unit has the following disc audio

languages to be selected: Original, English, Spanish, German, Italian, Portuguese, French, Russian, Chinese and Other.

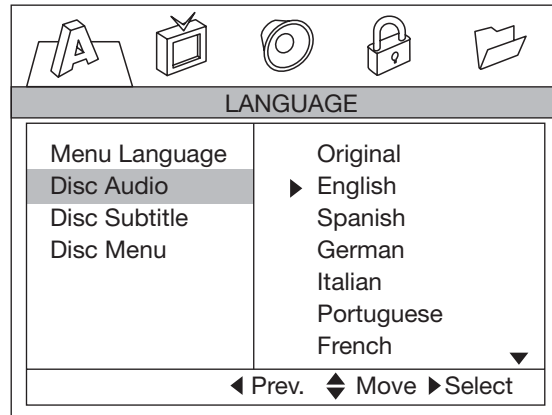

- “Disc Subtitle” and “Disc Menu” are similar with “Disc Audio”; the function is to set a preset value for the playback subtitle and menu display language of the DVD.

SETUP

DISPLAY SETUP

- When you open the **DISPLAY** menu, you will see the following picture:

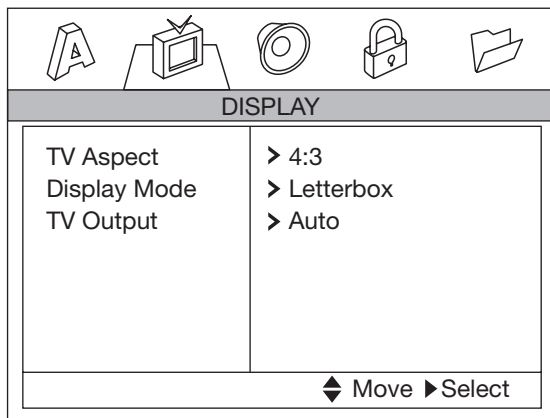

- “TV Aspect” is used to set the appropriate display effect when wide-screen video material is played on a conventional screen. There are two options to be selected: 4:3 and 16:9. When a wide-screen TV set is connected, you can select “16:9” to get better view effect.
- “Display Mode” can be changed when you set “4:3” in the “TV Aspect”. There are Letterbox and Panscan to be selected.
 - Letterbox: Display the picture of the cinema effect with the black bands at the top and bottom of the screen.
 - Panscan: Display the picture of the clipped TV screen. The left and right edges are cut off.
- “TV Output” is used to select the TV output mode. This player can play discs recorded in either PAL or NTSC format. Select NTSC format, when the unit is connected to NTSC TV. Select PAL format, when the unit is connected to PAL TV. Select AUTO format, the player TV output format will be according to the DVD disc format.

AUDIO SETUP

- When you open the **AUDIO** menu, you will see the following picture:

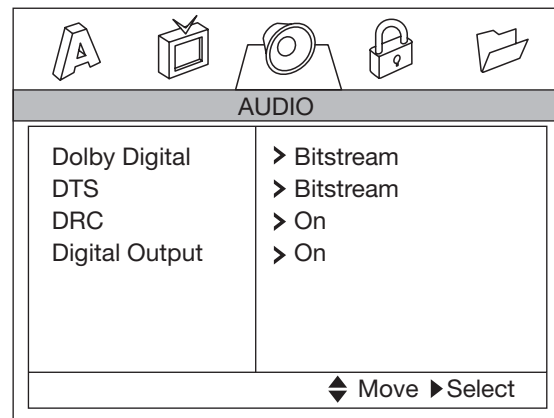

- “Dolby Digital” means the Dolby digital out type. There are “Bitstream” and “PCM” to be selected.
 - Bitstream: When connecting to the amplifier or other devices with the Dolby Digital Decoder, DTS Decoder or MPEG Decoder or other devices, select this item.
 - PCM (Pulse Code Modulation): When connect to the amplifier with two channels digital stereo, select this item. When playing a DVD disc with Dolby Digital and recorded by MPEG1 or MPEG2 record system, the DVD player will output the audio in PCM2 playback mode.
- “DTS” means “Date Transmission System”. There are “Bitstream” and “PCM” to be selected.
- “DRC” means “Dynamic Range Control”. There are ON/OFF to be selected. When it is set to “ON”, you can listen to the film sound effect with lower volume under the circumstance of not losing the sound definition.
- “Digital Output” is to activate the digital audio output on or off.

SETUP

LOCK SETUP

- When you open the **LOCK** setup page, you will see the following picture:

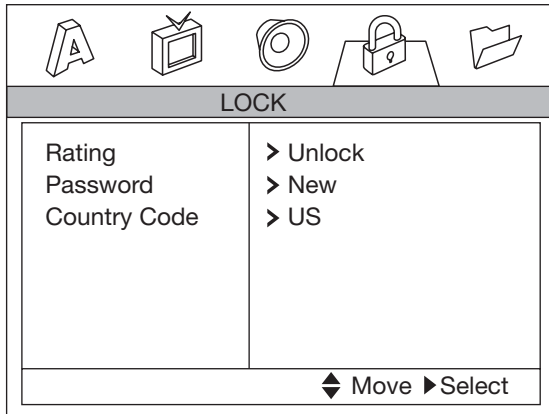

- “Rating” is used to set the parent control level.

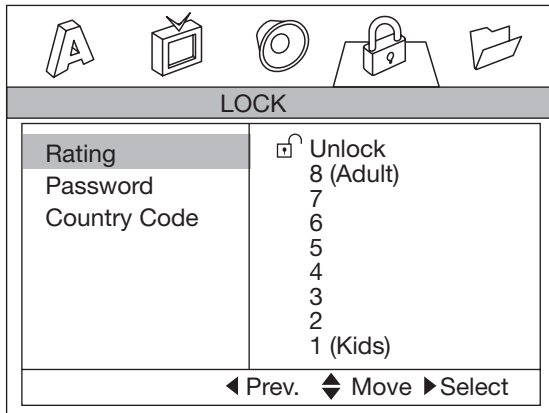

- When you enter into this item, the system will require you to input the password, only the password is correct, can you be permitted to change the parent lock level. Then you must input the password “3351”.
- If you find it wrong in the course of inputting the password, press **CLR** button to clear the inputted character.
- When you input the correct password, you can use **▲/▼** buttons to change the parent level. Here provide 9 kinds of level including 1~8 and unlock.
- Regarding to the levels, please refer to the “PARENT CONTROL”.
- When you complete the set in the setup, you must eject/load the disc from the disc slot, and then the function will come into effect.
- “Password” setup is used to set the new password or change the old password; before you enter into this item, the system will require you to input the old password, only the password is correct, can you be permitted to change the password.
- “Country Code” is used to set the country code. The code information standing for original producing area country will be

written in every DVD disc when it is produced. There are two characters standing for the name of the country. For example, CN for China, CA for Canada, and so on. Only when the country code you set in the SETUP menu matches with the disc’s own country code, the parent level that you set will come into effect.

The detail operation is:

- When you first set this item, it will display “NEW” and require you to input a new password, then input the password again to confirm it.
- Then the first character of the country code will be selected, you can use **▲/▼** buttons to select upward or downward to confirm the first character;
- When you confirm the first character, the second character will change into all the characters that may match with the first character to stand for the corresponding country code;
- Then use **▲/▼** buttons to select the second character;
- Press **OK** button to confirm the setting for country code.

Note:

If you have set a password in “Rating” and “Password”, when you set the country code, it will require you to input the password. Only when the password is correct, can you be permitted to change the country code. If you select “Load Default” in SETUP menu, the password you have set will be cleared.

OTHERS SETUP

- When you enter into the OTHERS setup page, you will see the following picture. You can change the setting for Load Default and Screen Saver.

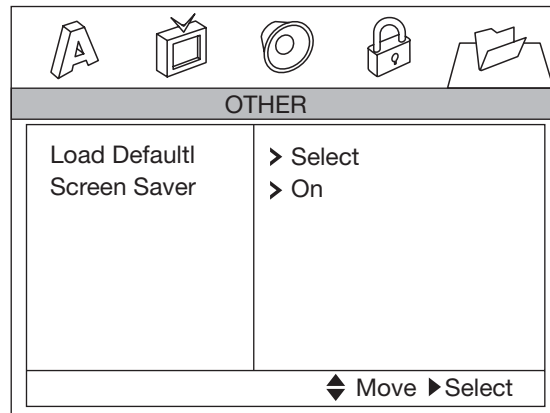

- “Load Default” is used to revert to factory initial settings.
- “Screen Saver” is used to switch on/off the screen saver function.

TROUBLE SHOOTING

If it appears that your DVD unit is faulty, first consult this checklist. It may be that something simple has been overlooked.

Under no circumstances should you try to repair the player yourself, as this will invalidate the warranty. Only qualified service personnel can remove the cover or service this player.

NO POWER

- If the power supply is connected to the car accessory circuits, but the engine is not moving, switch the ignition key to "ACC".
- Check if the fuse is blown. Then replace the new fuse.
- Check if the on/off button on the front of the player is set to on.

NO PICTURE

- Check if the monitor or TV is switched on.
- Check if select proper mode, such as Disc Play mode and AV mode.
- Check the video connection.

DISTORTED PICTURE

- Check the disc for fingerprints and clean with soft cloth, wiping from centre to edge.
- Sometimes a small amount of picture distortion may appear. This is not a malfunction.

COMPLETELY DISTORTED PICTURE

- The disc format is not according to the TV-set used (PAL/NTSC).

NO COLOR IN PICTURE

- The disc format is not according to the TV-set used (PAL/NTSC).

DISC DOES NOT PLAY

- Ensure the disc label is upwards.
- Clean the disc.
- Check if the disc is defective by trying another disc.

NO SOUND

- Check audio connections.
- If using a HIFI amplifier, try another sound source.

DISTORTED SOUND FROM HIFI AMPLIFIER

- Check to make sure that no audio connections are made to the amplifier phono input.

THE PLAYER DOES NOT RESPOND TO THE REMOTE CONTROL

- Aim the remote control directly at the sensor on the front of the player.
- Avoid all obstacles which may interfere with the signal path.
- Inspect or replace the remote control battery.

DISTORTED OR B/W PICTURE

- The disc format is not according to the TV-set used (PAL/NTSC).

NO AUDIO AT DIGITAL OUTPUT

- Check the digital connections
- Check the Digital Audio menu to make sure that the digital output is correctly set.
- Check if the audio format of the selected audio language matches your receiver's capabilities.

BUTTONS DO NOT WORK

- Press Reset button on the housing of the DVD unit.

THE RADIO DOES NOT WORK

- Check if the antenna cable is connected firmly.

THE RADIO STATION AUTOMATIC SELECTION DOES NOT WORK

- If the signals are too weak, select a station manually.

SPECIFICATIONS

GENERAL

Power Supply Requirements	: 12V DC (11V-15V), test voltage 14.4V, Negative Ground
Chassis Dimensions	: 178 (W) x 160 (D) x 50 (H)
Tone Controls	
- Bass (at 100 Hz)	: ± 10 dB
- Treble (at 10 KHz)	: ± 10 dB
Maximum Output Power	: 4 x 40 watts
Current Drain	: 5 Ampere (max.)

CD PLAYER

Signal to Noise Ratio	: More than 55 dB
Channel Separation	: More than 45 dB
Frequency Response	: 20 Hz - 20 kHz

RADIO

	FM
Frequency Coverage	: 88 to 108MHz
IF	: 10.7 MHz
Sensitivity (S/N = 30 dB)	: 8 μ V
Stereo Separation	: > 25 dB

	AM
Frequency Coverage	: 530 to 1710 kHz
IF	: 450 kHz
Sensitivity (S/N = 20 dB)	: 38 dBu

SPECIFICATIONS

Video signal system	: Composite video 1.0Vp-p 75Ω
Discs Played	: (1) 5" (12 cm) DVD-VIDEO disc (2) Compact Disc (CD-DA/CD-R/CD-RW/MP3) (3) 5" (12cm) VIDEO CD
Audio Output Level	: 10kΩ (2 ch 2.0 Vrms)

Note:

Specifications and design are subject to modification, without notice, due to improvements in technology.

CAUTION:

- To avoid electric shock, this unit must not be exposed to dripping water or water splash.
- Minimum distances around the apparatus for sufficient ventilation.
- The ventilation should not be impeded by covering the ventilation openings with items, such as newspapers, table-cloths, curtains, etc.
- No naked flame sources, such as lighted candles, should be placed on the apparatus.
- The use of apparatus in tropical and/or moderate climates.
- Before scrapping the appliance, remove the batteries and place them in the appropriate battery collection container.

This product incorporates copyright protection technology that is protected by method claims of certain U.S. patents and other intellectual property rights owned by Macrovision Corporation and other rights owners. Use of this copyright protection technology must be authorized by Macrovision Corporation, and is intended for home and other limited viewing uses only unless otherwise authorized by Macrovision Corporation. Reverse engineering or disassembly is prohibited.